

# Product data sheet

Specifications



## miniature, Harmony Electromechanical Relays, 5A, 2CO, without LED, 24V DC

RXM2LB1BD

**Product availability: Non-Stock - Not normally stocked in distribution facility**

**Price\*: 4.83 USD**

### Main

Range of Product	Harmony Electromechanical Relays
Coil interference suppression	Without
Series name	Miniature
Product or Component Type	Plug-in relay
Device short name	RXM
Contacts type and composition	2 C/O
[Ithe] conventional enclosed thermal current	5 A -40...131 °F (-40...55 °C)

### Complementary

Contact operation	Standard
[Uc] control circuit voltage	24 V DC
Status LED	Without
Control Type	Without push-button
[Uimp] rated impulse withstand voltage	4 kV 1.2/50 µs IEC 61810-7
[Ie] rated operational current	5 A AC-1/DC-1) NO IEC 2.5 A AC-1/DC-1) NC IEC 1 A 28 V DC-13) NO
Minimum switching capacity	25 mW subject to switching frequency, environment or expected reliability level etc
Operating time	20 ms between coil de-energisation and making of the Off-delay contact 20 ms between coil energisation and making of the On-delay contact
CAD overall width	0.8 in (21 mm)
CAD overall height	1.06 in (27 mm)
CAD overall depth	1.8 in (46 mm)
Minimum switching current	5 mA subject to switching frequency, environment or expected reliability level etc
Minimum switching voltage	5 V subject to switching frequency, environment or expected reliability level etc
Rated operational voltage limits	19.2...26.4 V DC
[Ui] rated insulation voltage	250 V IEC
Maximum switching voltage	250 V AC 28 V DC
Drop-out voltage threshold	>= 0.1 U <sub>c</sub> DC
Load current	5 A 250 V AC 5 A 28 V DC

Price is "List Price" and may be subject to a trade discount – check with your local distributor or retailer for actual price.

<b>Maximum switching capacity</b>	1250 VA AC 140 W DC
<b>Average resistance</b>	640 Ohm at 73 °F (23 °C) +/- 10 %
<b>Average coil consumption</b>	0.9 W, DC
<b>Mechanical durability</b>	10000000 cycles
<b>Electrical durability</b>	100000 cycles for resistive load 50000 cycles, 1 A at 28 V, DC-13 NO
<b>Safety reliability data</b>	B10d = 100000
<b>Operating rate</b>	<= 1200 cycles/hour under load <= 18000 cycles/hour no-load
<b>Utilisation coefficient</b>	20 %
<b>Dielectric strength</b>	2000 V AC between coil and contact with basic insulation 2000 V AC between poles with basic insulation 1000 V AC between contacts with micro disconnection
<b>Protection category</b>	RT I
<b>Pollution degree</b>	3
<b>Operating position</b>	Any position
<b>Test levels</b>	Level A group mounting
<b>Sale per indivisible quantity</b>	10
<b>Contacts material</b>	Silver alloy (Ag/Ni)
<b>Net Weight</b>	0.071 lb(US) (0.032 kg)

## Environment

<b>IP degree of protection</b>	IP40 conforming to IEC 60529
<b>Standards</b>	CE IEC 61810-1 (iss. 2)
<b>Ambient Air Temperature for Storage</b>	-40...185 °F (-40...85 °C)
<b>Vibration resistance</b>	3 gn +/- 1 mm 10...50 Hz)operating IEC 60068-2-6 6 gn +/- 1 mm 10...50 Hz)not operating IEC 60068-2-6
<b>Shock resistance</b>	30 gnot operating IEC 60068-2-27 10 gnin operation IEC 60068-2-27

## Ordering and shipping details

<b>Category</b>	US1CP4B22153
<b>Discount Schedule</b>	CP4B
<b>GTIN</b>	3389119215152
<b>Returnability</b>	No
<b>Country of origin</b>	CN

## Packing Units

<b>Unit Type of Package 1</b>	PCE
<b>Number of Units in Package 1</b>	1
<b>Package 1 Height</b>	1.61 in (4.1 cm)
<b>Package 1 Width</b>	0.83 in (2.1 cm)
<b>Package 1 Length</b>	1.10 in (2.8 cm)

<b>Package 1 Weight</b>	1.3 oz (37.0 g)
<b>Unit Type of Package 2</b>	BB1
<b>Number of Units in Package 2</b>	10
<b>Package 2 Height</b>	1.61 in (4.1 cm)
<b>Package 2 Width</b>	0.83 in (2.1 cm)
<b>Package 2 Length</b>	1.10 in (2.8 cm)
<b>Package 2 Weight</b>	13.8 oz (390.0 g)
<b>Unit Type of Package 3</b>	S02
<b>Number of Units in Package 3</b>	270
<b>Package 3 Height</b>	5.91 in (15.0 cm)
<b>Package 3 Width</b>	11.81 in (30.0 cm)
<b>Package 3 Length</b>	15.75 in (40.0 cm)
<b>Package 3 Weight</b>	23.027 lb(US) (10.445 kg)

## Contractual warranty

<b>Warranty</b>	18 months
-----------------	-----------

## Environmental Data

Schneider Electric aims to achieve Net Zero status by 2050 through supply chain partnerships, lower impact materials, and circularity via our ongoing “Use Better, Use Longer, Use Again” campaign to extend product lifetimes and recyclability.

[How this information helps you >](#)

### Environmental footprint

Carbon footprint (kg CO2 eq, Total Life cycle)	13
--	----

Environmental Disclosure	<a href="#">Product Environmental Profile</a>
--------------------------	---

## Use Better

### Materials and Substances

Packaging made with recycled cardboard	Yes
--	-----

Packaging without single use plastic	Yes
--------------------------------------	-----

<a href="#">EU RoHS Directive</a>	Pro-active compliance (Product out of EU RoHS legal scope)
-----------------------------------	--

REACH Regulation	<a href="#">REACH Declaration</a>
------------------	-----------------------------------

China RoHS Regulation	<a href="#">China RoHS declaration</a>
-----------------------	--

California proposition 65	<b>WARNING:</b> This product can expose you to chemicals including: Nickel compounds, which is known to the State of California to cause cancer, and Diisodecyl phthalate (DIDP), which is known to the State of California to cause birth defects or other reproductive harm. For more information go to <a href="http://www.P65Warnings.ca.gov">www.P65Warnings.ca.gov</a>
---------------------------	--

# Use Again

## Repack and remanufacture

Circularity Profile

[End of Life Information](#)

WEEE



The product must be disposed on European Union markets following specific waste collection and never end up in rubbish bins.

Take-back

No

Dimensions Drawings

Dimensions

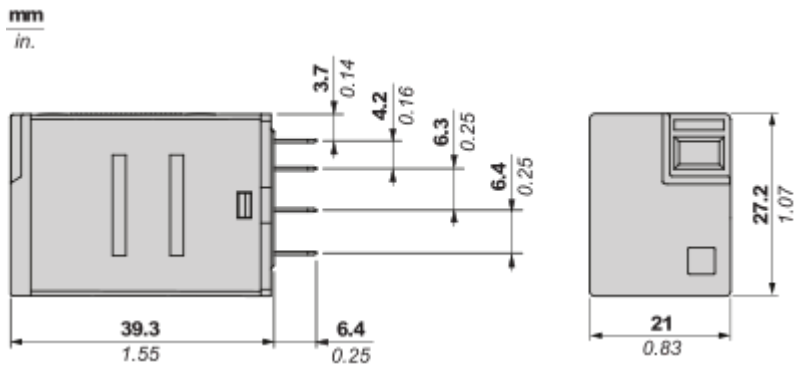

Pin Side View

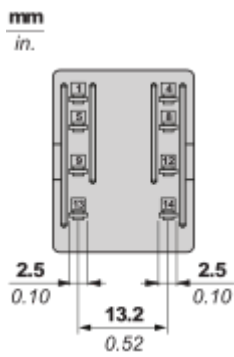

Connections and Schema

Wiring Diagram

---

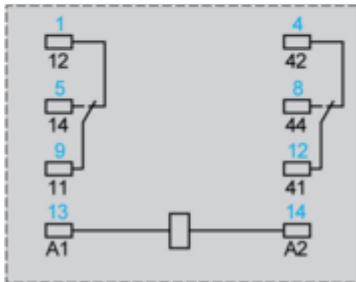
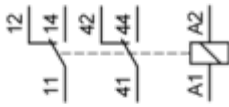

Symbols shown in blue correspond to Nema marking.

Performance Curves

Electrical Durability of Contacts

**Durability (inductive load) = durability (resistive load) x reduction coefficient.**

For 2 Poles Relay

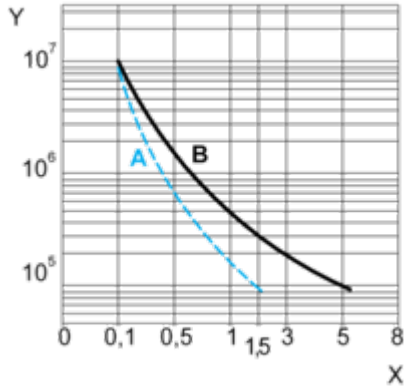

**X** : Contact current (A)

**Y** : Durability (Number of operating cycles)

**A** : Inductive load

**B** : Resistive load

**Note** : These are typical curves, actual durability depends on load, environment, duty cycle, etc.

For inductive load, to increase relay life cycles, please add a proper load protection circuit (eg: RC protection/Varistor/free Wheeling diode -DC load only- )



**Maximum Switching Capacity**

---

For 2 Poles Relay

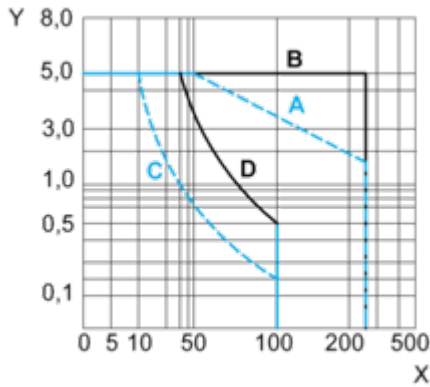

X : Contact voltage (v)

Y : Contact current (A)

A : Inductive AC load

B : Resistive AC load

C : Inductive DC load

D : Resistive DC load

**Note :** These are typical curves, actual durability depends on load, environment, duty cycle, etc.

For inductive load, to increase relay life cycles, please add a proper load protection circuit (eg: RC protection/Varistor/free Wheeling diode -DC load only- )

For low level loads (below 10mA), we recommend to use RXM\*GB series with bifurcated contacts relays instead.

Technical Illustration

Dimensions

---

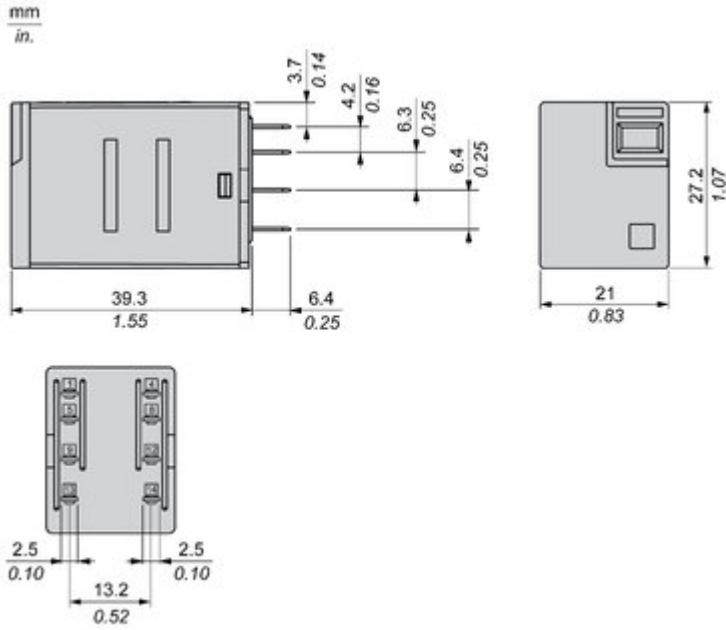

Offer Marketing Illustration

Product benefits / Features

---

## Features

### Easy Harmony RXMLB Relay



Fit to customer needs  
coverage of most general  
control panel applications



Easy to select  
simple selection and  
wide availability



Convenient to use  
Easy status readiness  
through mechanical  
indicator & LED



Safe to perform  
product reliability,  
compliance with  
industrial standard  
and eco-design

Offer Marketing Illustration

Product benefits / Features

---

## Technical Benefits

### Easy Harmony RXMLB Relay

RXM\*LB sockets:

- Mixed contact arrangement
- Screw clamp terminal

Metal maintaining clamp:  
reliable in vibration  
environment

Finger grip cover to  
easily remove relay  
from socket

RXM\*LB sockets:

- 2CO-5A, 4CO-3A
- 12-110VDC, 24-230VAC

Mechanical indicator  
for contact status

"Power On" LED for  
relays status



Image of product / Alternate images

Alternative

---



